

# DEKKON™

## Instruction manual

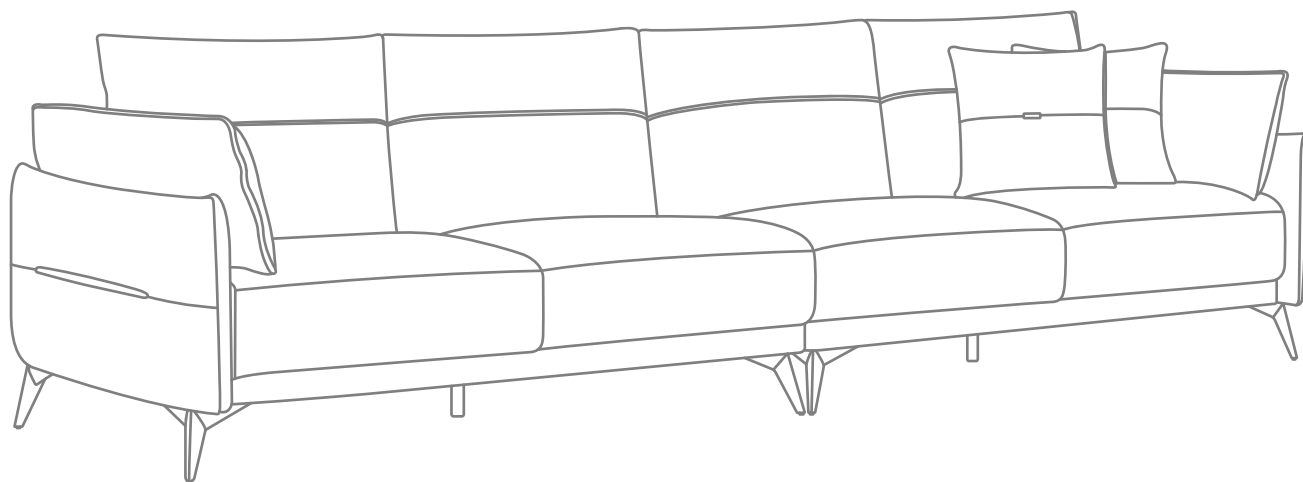

[Sofa] **Baffin Sofa Big 4-Seater**

## Parts list



A sofa L \* 1



B sofa R \* 1

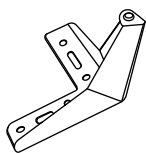

C metal foot \* 8



D iron mid-foot \* 2

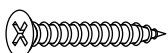

E self tapping screw \* 32



F double screw \* 2

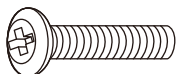

G bevel cross bolt \* 12









H pad \* 12

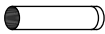

I phillips screwdriver \* 1





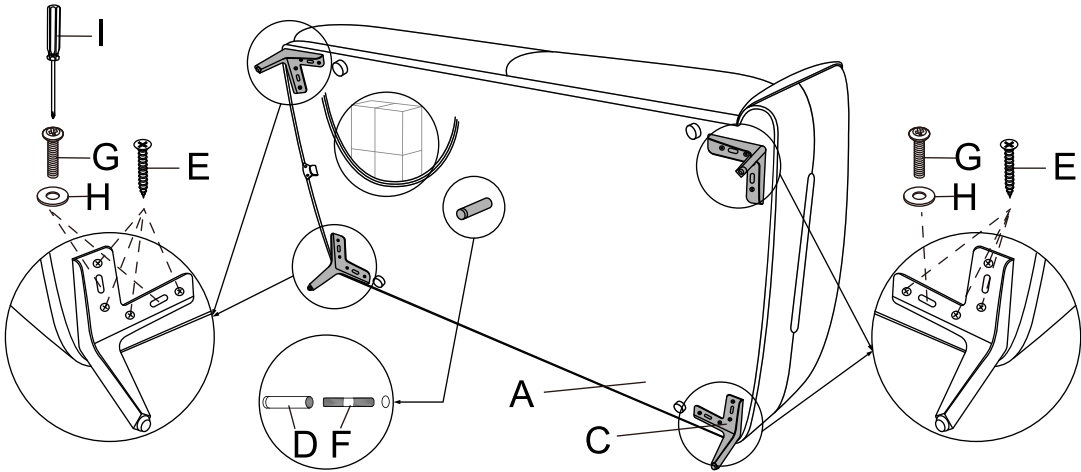

# Assembly

**1**

|  |   |   |   |  |  |   |
|--|---|---|---|--|--|---|
| C x 4 pcs<br> | D x 1 pc<br> | E x 16 pcs<br> | F x 1 pc<br> | G x 6 pcs<br> | H x 6 pcs<br> | I x 1 pc<br> |
|--|---|---|---|--|--|---|



**2**

|  |   |   |   |  |  |   |
|--|---|---|---|--|--|---|
| C x 4 pcs<br> | D x 1 pc<br> | E x 16 pcs<br> | F x 1 pc<br> | G x 6 pcs<br> | H x 6 pcs<br> | I x 1 pc<br> |
|--|---|---|---|--|--|---|

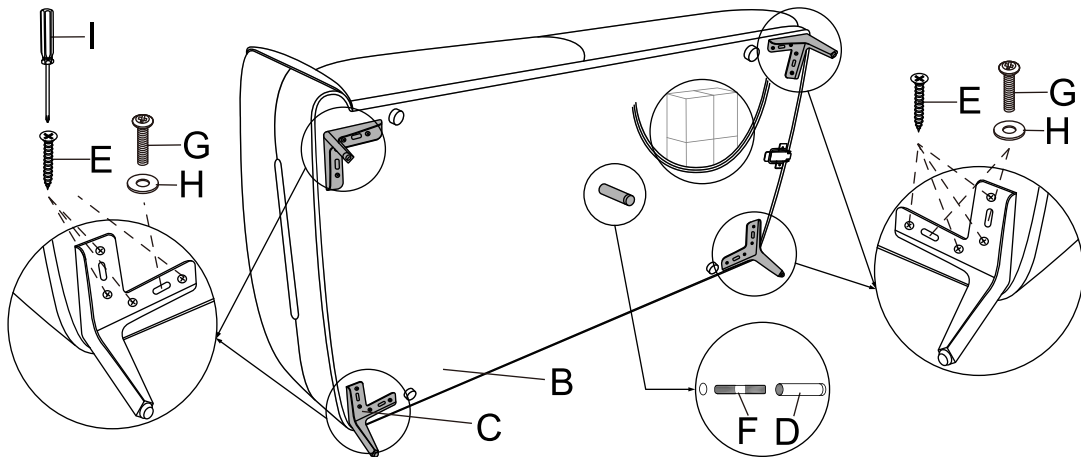

# Assembly

- 3** Put the sofa L and sofa R together, and lock the metal buckle at the bottom of the seat frame.

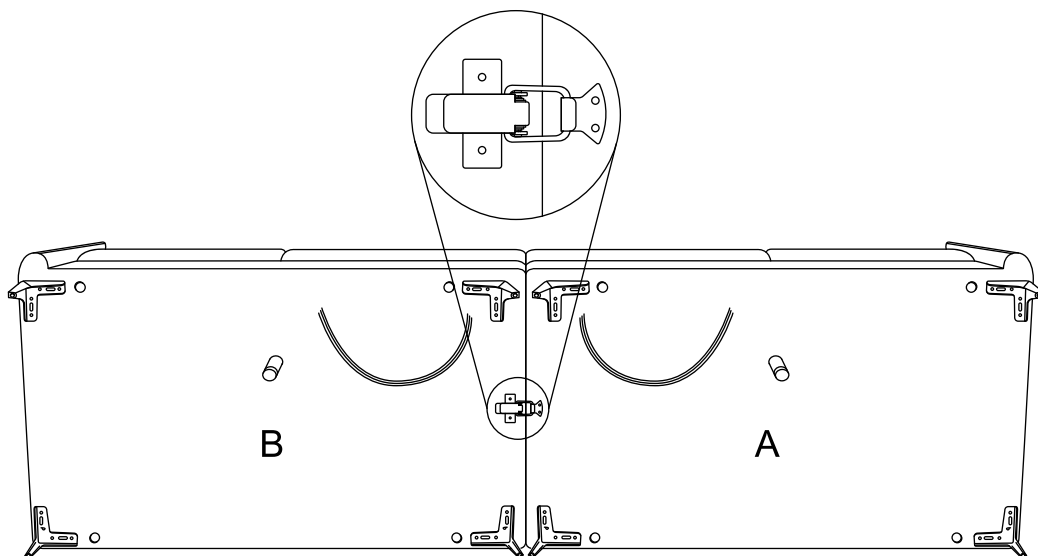

**4**

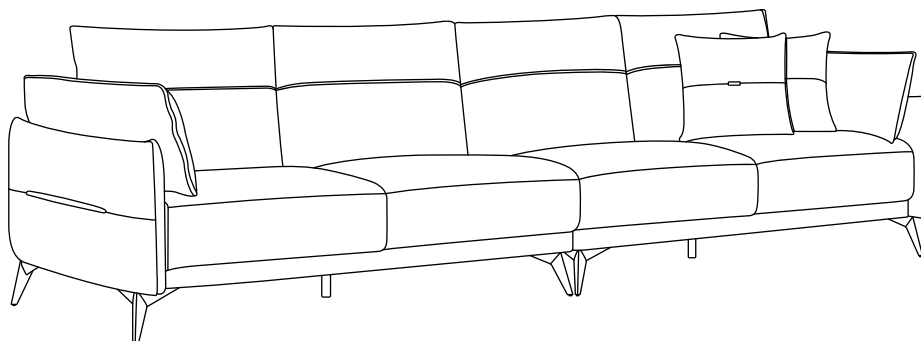

# Notice

EN

- **First fix screws lightly by hand and at the end of the assembly fasten the screws firmly with tools.**
- Please use the chair after you are fully familiar with the use of the usage and operation.
- This product can only be used when all screws and parts are tightened. Check the tightening screws and parts at least every three months.
- Clean the furniture with a damp cloth and/or neutral soap. Dry them with a completely dry cloth. We advise against the use of aggressive solvent cleaning products or any other chemical product that can be used for cleaning.
- Do not stand on top of the furniture. Use it exclusively for the function that has been acquired.
- We warrants all parts of the product to be free from defects in workmanship and materials for a period of 2 years from the date of receipt by the consumer.

ES

- **Primero fije los tornillos ligeramente a mano y al final del montaje apriéte los firmemente con herramientas.**
- Utilice la silla después de estar completamente familiarizado con el uso y el funcionamiento.
- Este producto sólo se puede utilizar cuando todos los tornillos y piezas están apretados. Compruebe los tornillos y piezas de apriete al menos cada tres meses.
- Limpiar los muebles con un paño húmedo y/o jabón neutro. Sécalas con un paño completamente seco. Desaconsejamos el uso de productos de limpieza agresivos con disolventes o cualquier otro producto químico que pueda utilizarse para la limpieza.
- No se pare encima de los muebles. Úselo exclusivamente para la función que ha adquirido.
- Garantizamos que todas las piezas del producto están libres de defectos de mano de obra y materiales durante un período de 2 años a partir de la fecha de recepción por parte del consumidor.

FR

- **Fixez d'abord les vis légèrement à la main et à la fin de l'assemblage, fixez fermement les vis avec des outils.**
- Veuillez utiliser le fauteuil une fois que vous êtes parfaitement familiarisé avec son utilisation et son fonctionnement.
- Ce produit ne peut être utilisé que lorsque toutes les vis et pièces sont serrées. Vérifiez les vis et les pièces de serrage au moins tous les trois mois.
- Nettoyez les meubles avec un chiffon humide et/ou du savon neutre. Séchez-les avec un chiffon complètement sec. Nous déconseillons l'utilisation de produits nettoyants à base de solvants agressifs ou tout autre produit chimique pouvant être utilisé pour le nettoyage.
- Ne vous tenez pas debout sur les meubles. Utilisez-le exclusivement pour la fonction acquise.
- Nous garantissons que toutes les pièces du produit sont exemptes de défauts de fabrication et de matériaux pendant une période de 2 ans à compter de la date de réception par le consommateur.

DE

- **Ziehen Sie die Schrauben zunächst leicht von Hand an und ziehen Sie die Schrauben am Ende der Montage mit Werkzeug fest an.**
- Bitte benutzen Sie den Stuhl, nachdem Sie mit der Verwendung und Bedienung vollständig vertraut sind.
- Dieses Produkt kann nur verwendet werden, wenn alle Schrauben und Teile festgezogen sind. Überprüfen Sie die Befestigungsschrauben und -teile mindestens alle drei Monate.
- Reinigen Sie die Möbel mit einem feuchten Tuch und/oder neutraler Seife. Trocknen Sie sie mit einem völlig trockenen Tuch ab. Wir raten von der Verwendung aggressiver Lösungsmittelreiniger oder anderer chemischer Produkte ab, die zur Reinigung verwendet werden können.
- Stellen Sie sich nicht auf die Möbel. Benutzen Sie es ausschließlich für die erworbene Funktion.
- Wir garantieren für einen Zeitraum von 2 Jahren ab dem Datum des Erhalts durch den Verbraucher, dass alle Teile des Produkts frei von Verarbeitungs- und Materialfehlern sind.